

Produkt no.: 002350

Ø103mm 350 ml. Serving bowl 2350

Information:

Material:	Food Approved PS
Volume under Lid:	270 ml.
Tamper evident:	Yes
Diam:	A = Ø 102,6 mm
Height:	B = 61,30 mm
IML:	No

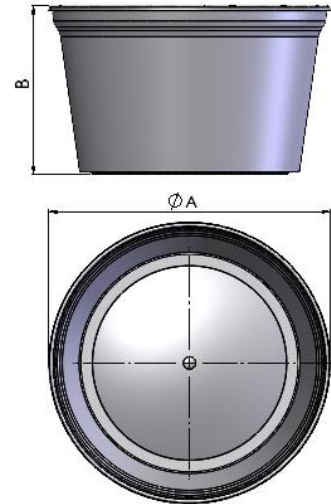

EU Pallet dimension: 1200 x 800

Total quantity per pallet/pallet place:

100 pcs. in each bag



1 box 10 bags of 100 pcs. = 1000 pcs.

12 boxes for each pallet

Total of 120 bags = 12.000 pcs. for each pallet.

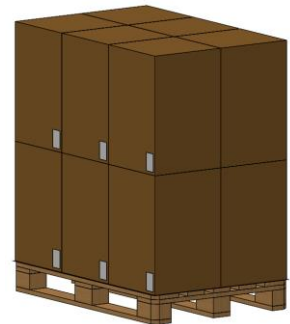

Hot temperature:

Plastic packaging can become flexible when subjected to hot filling temperatures and care must be taken in relation to stacking immediately after hot filling. The Kellpo packaging must be tested by the customer with the actual product before approval for use at hot temperatures.

Cold temperature:

Freezing conditions require special resins available on request otherwise the packaging could crack. The Kellpo packaging must be tested by the customer with the actual product before approval for use at low temperatures.

Shelf life:

The compliance of the product to the technical specifications in this data sheet is guaranteed for 24 months after the date of the delivery subject to suitable storage. Suitable storage includes protection of e.g. direct sun light, rain, very low temperatures, or very high temperatures over a long period.

Quality specifications

The product complies with the requirements in Commission Regulation (EU) No 10/2011 on plastic materials and articles intended to come into contact with food as amended by implementing Regulation (EU) No 321/2011, No 1282/2011, 1183/2012, 202/2014, 2015/174, 2016/1416, 2017/752, 2018/79, 2018/213, 2018/831, 2019/37, 2019/1338 and 2020/1245.